

Filix

Energy efficient downlight with a wide beam angle

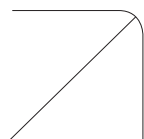

Filix is a family of downlights targeted at refurbishment to replace compact fluorescent downlights. Filix comes in two sizes with a cut out size of 170 mm or 200 mm with an extra wide ring frame to fit existing cut outs. Filix has a wide beam angle for general applications and ranges between 1400 lm up to 2000 lm and to match the typical light levels of compact fluorescent downlights.

- **Easy energy savings**
- **Cost efficient**
- **Easy to install**
- **Perfect for refurbishment**
- **5 year guarantee**

IP44



LED



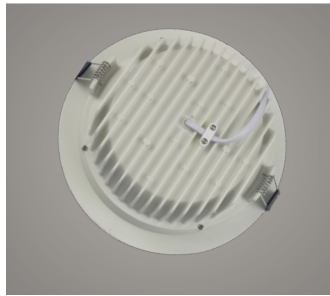
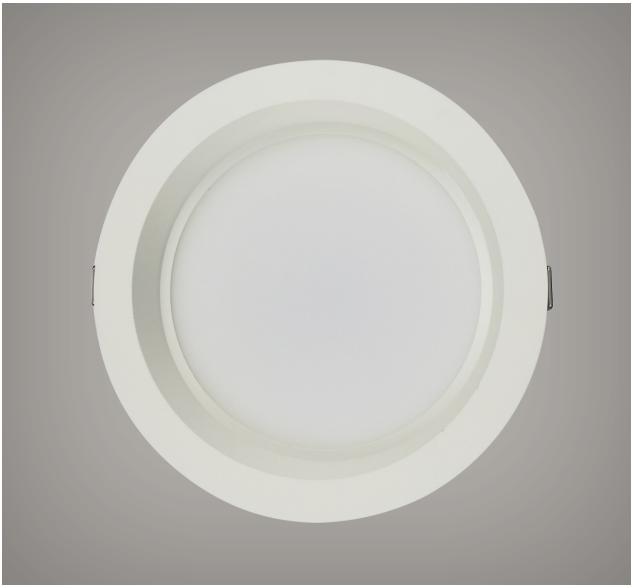

APPLICATIONS: Public areas, offices and corridors.

MATERIAL: AL+PMMA. Housing made of die cast aluminum. Frame colour RAL 9010.

INSTALLATION AND CONNECTION: Easily installed to ceiling via spring mount. Supplied with driver and 2,5 m cable and plug.

TECHNICAL DATA: LED. Philips Xitanium on/off driver. LED light source Everlight 2835. SDCM <5. AC200-240V, 50/60Hz. IP44. Class II. Energy class A+. PF >0.9. UGR 22. Ambient temperature 0°C -+45°C. CRI >80. Beam angle 90°. Lifetime 50,000 hours (L70B50 at 25°C Ta). CE.

	TYPE	SYSTEM POWER (W)	LUMINOUS FLUX (lm)	EFFICACY (lm/W)	DIMENSIONS	C-C (mm)	ENERGY CLASS	ART NO.	
MODELS	Filix on/off								
	Filix RE D195 15W 1400 On/Off 830	15	1400	93	Ø195*72H	170	A+	468115	
	Filix RE D195 15W 1400 On/Off 840	15	1400	97	Ø195*72H	170	A+	468116	
	Filix RE D195 20W 1900 On/Off 830	20	1900	95	Ø195*72H	170	A+	468117	
	Filix RE D195 20W 1900 On/Off 840	20	1900	98	Ø195*72H	170	A+	468118	
	Filix RE D235 20W 2000 On/Off 830	20	2000	100	Ø235*79H	200	A+	468119	
	Filix RE D235 20W 2000 On/Off 840	20	2000	103	Ø235*79H	200	A+	468120	
	Filix RE D235 15W 1400 On/Off 830 CWP-2,5m	15	1400	93	Ø235*79H	200	A+	468113	
	Filix RE D235 15W 1400 On/Off 840 C2L-1,5m	15	1400	93	Ø235*79H	200	A+	468114	
	Filix DALI								
	Filix RE D235 15W 1400 DALI 830	15	1400	93	Ø235*79H	200	A+	468121	
	Filix RE D235 15W 1400 DALI 840	15	1400	93	Ø235*79H	200	A+	468122	
	Filix RE D195 15W 1400 DALI 830	15	1400	93	Ø195*72H	170	A+	468123	
	Filix RE D195 15W 1400 DALI 840	15	1450	97	Ø195*72H	170	A+	468124	
	Filix RE D195 20W 1900 DALI 830	20	1900	95	Ø195*72H	170	A+	468125	
	Filix RE D195 20W 1900 DALI 840	20	1950	97	Ø195*72H	170	A+	468126	
	Filix RE D235 20W 2000 DALI 830	20	2000	100	Ø235*79H	200	A+	468127	
	Filix RE D235 20W 2000 DALI 840	20	2050	103	Ø235*79H	200	A+	468128	
	Accessories							Article number	
	Cover ring downlight white 170/270 mm							468101	
Cover ring downlight white 200/320 mm							468102		

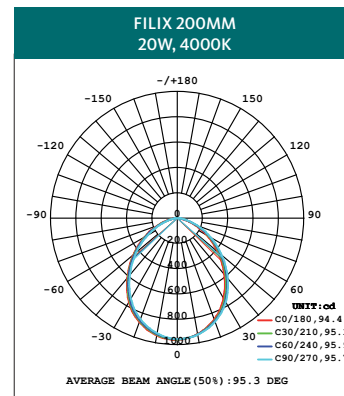
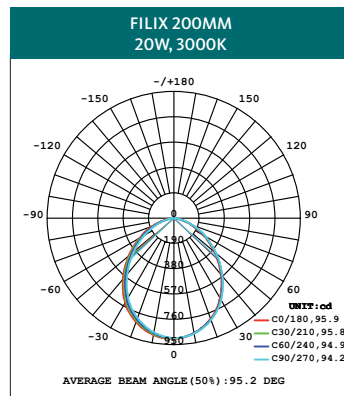
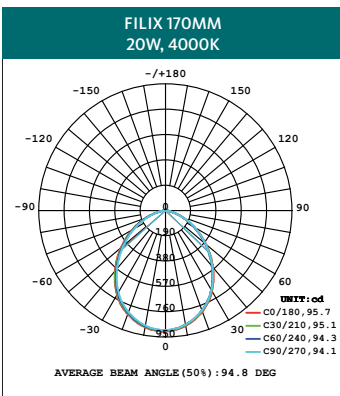
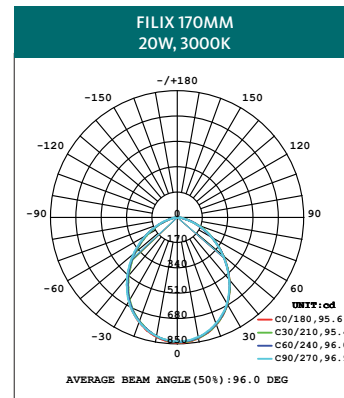
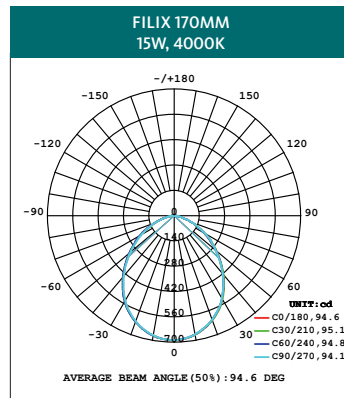
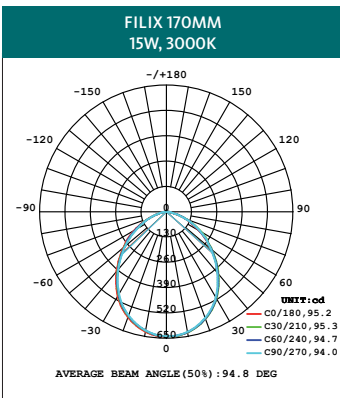
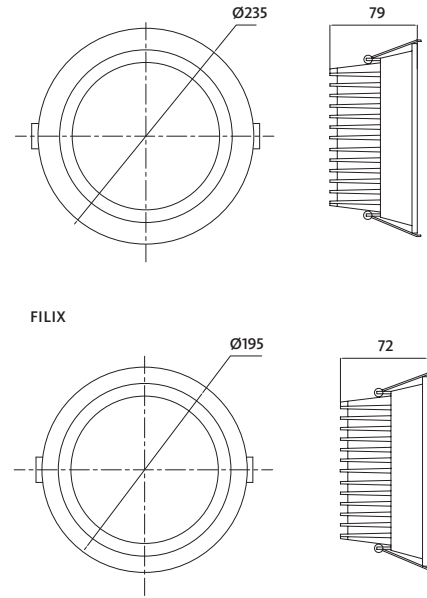

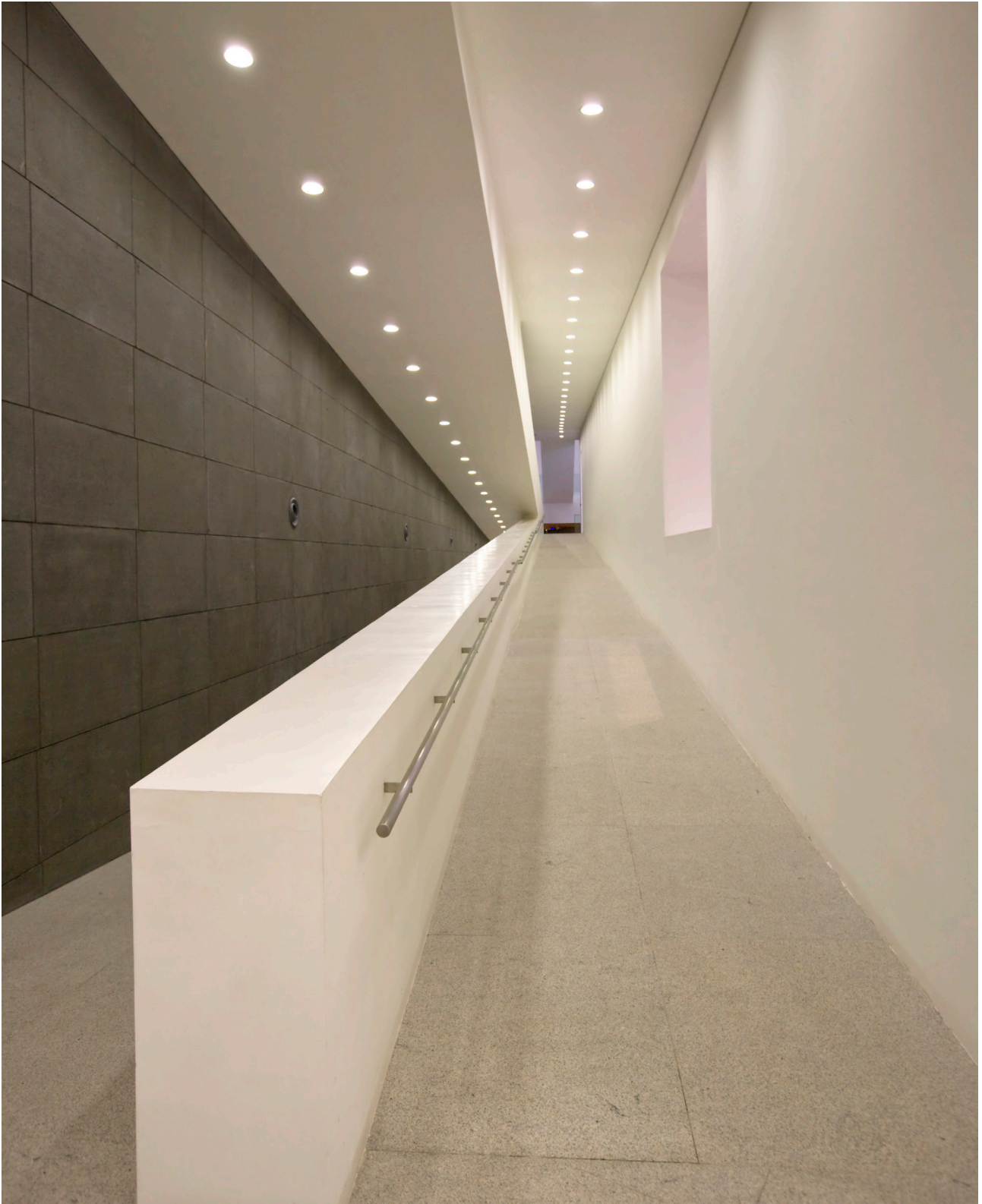

All specifications are subject to change. For the latest version of this product leaflet, please visit www.auralight.com/products.

2018-10-01